

Warning:

Always wear safety glasses when operating hand tool.

Instructions:

1. Tool is designed to accept 5/16" and 1/2" wide coated and uncoated ties.
2. Turn tension adjustment knob until desired tension setting is displayed in tension indicator window. Space between the numbers counts as one-half setting. See step 7.
3. Extend handle open to release gripping mechanism and insert clamp tail into tool through side load entry.
4. Squeeze handle repeatedly to tighten band around object. Be sure to release handle completely to use full pull-up stroke of tool. Buckle must be secure against the tool head. Once the preset tension has been reached, the handle will no longer release completely.
5. To cut off excess clamp tail, squeeze handle one last time.
6. The tool must be reset by extending the handle out until it snaps into place. The tool will now be ready to apply the next clamp.
7. Tension Setting Range:

.270" (6.9mm) Multi-Lok	1 - 5 1/2
.470" (11.9mm) Multi-Lok	1 - 6 1/2

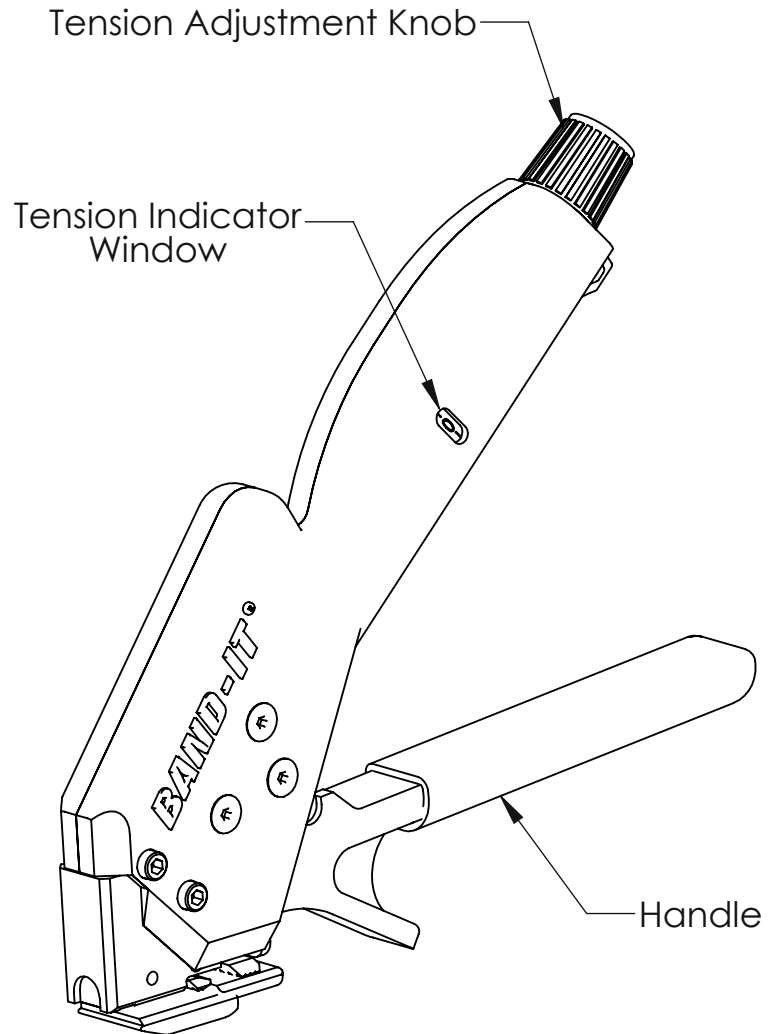

(see next page for part number tabulation)

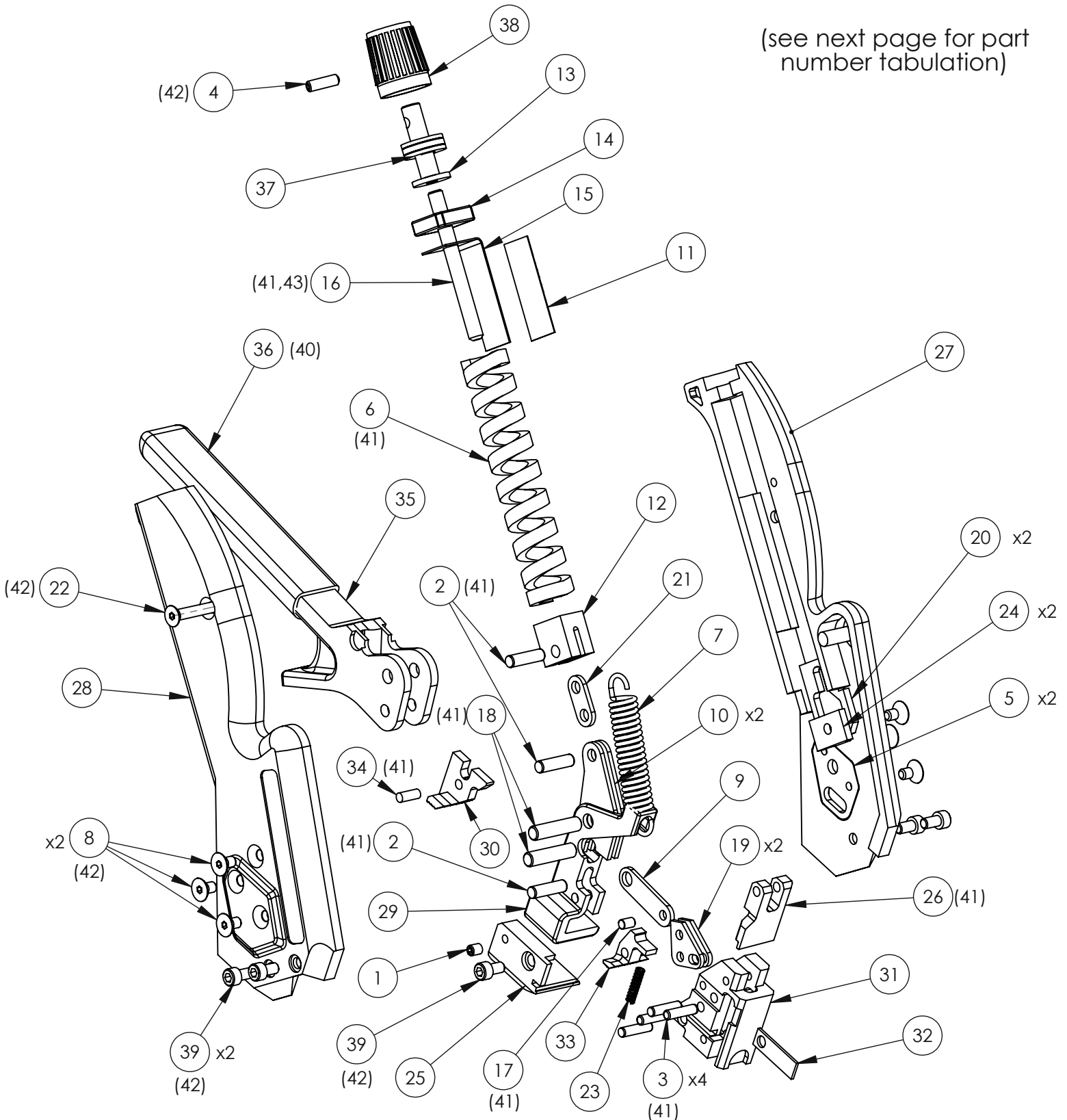

ITEM NO.	PART NUMBER	DESCRIPTION	QTY
1	A02887	SCREW, SET, #6-32 X .188 L	1
2	A73587	PIN, 5/32 DIA X .562 LONG	3
3	A84487	PIN, 1/8DIA X .50 LONG	4
4	A85687	SCREW, SET, #6-32 X .473 L	1
5	A91477	BODY PLATE, FRONT/SIDE LOAD TOOL	2
6	A91687	SPRING, DIE, 3.0L EXTRA HEAVY	1
7	A91787	SPRING, EXTENSION, 3/8 X 1.5" L	1
8	A91987	SCREW, FLAT, #6-32 X 1/4L	6
9	A92177	LINK, MIDDLE, CUTOFF	1
10	A92267	TENSION ARM, FRONT/SIDE LOAD TOOL	2
11	A92387	DECAL, TENSION INDICATOR	1
12	A92487	TENSION PLUNGER	1
13	A92577	TENSION CAP	1
14	A93487	BLOCK, TENSION	1
15	A93587	TENSION INDICATOR	1
16	A94488	SCREW, SET, #10-24 X 2.0 L	1
17	A94687	PIN, .125D X .19L	1
18	A94887	PIN, .188D X .78L	2
19	A94987	LINK, CUTOFF	2
20	A95387	TENSION PLATE	2
21	A95487	TENSION LINK	1
22	A96087	SCREW, FLAT, #6-32 X 3/4L	1
23	C09587	SPR, COMP, .12 DIA X .5L	1
24	K57887	PAD, CENTERING, TENSION ARM	2
25	K83987	BLADE, CUTOFF	1
26	K84087	KNIFE, CUTOFF, M503	1
27	K93487	BODY, LEFT, STANDARD	1
28	K93687	BODY, RIGHT, BLACK	1
29	K93788	PULL UP LEVER, SIDE LOAD	1
30	K93887	GRIPPER, PULLING	1
31	K94187	HEAD, SIDE LOAD	1
32	K94287	KNIFE COVER	1
33	K94387	GRIPPER, HOLDING	1
34	K97487	PIN, .125" DIA X .313" L	1
35	K97587	HANDLE, FRONT/SIDE LOAD TOOL	1
36	M50887	GRIP,TEXT .437ID X 3.25 LG, YELLOW	1
37	M53287	BEARING, THRUST, .250 ID X .462 OD	1
38	M53387	KNOB, ADJUSTMENT, .250 SHAFT	1
39	M54587	SCREW, CAP, #6-32 X .25 L	5
40	-	ADHESIVE, CYANOACRYLATE	-
41	-	GREASE, EXTREME PRESSURE	-
42	-	BLUE LOCTITE (MEDIUM STRENGTH)	-
43	-	RED LOCTITE (HIGH STRENGTH)	-

Tools Required:

Hex Keys: 1/16", 7/64"

Parts May Be Required:

Blade: K83987

Cap Screw: M54587

Set Screw: A02887

Special Instructions:

It is critical the knife and blade be assembled with a zero-gap to ensure clean cut-off. Once correctly positioned, use threadlocking compound to prevent parts from shifting during use (allow sufficient time for compound to cure).

Installation Procedure:

1. Set the tool tension to -0-.
2. Back-out cap screw (M54587) and set screw (A02887) - Figure 1.
3. Reposition/replace blade, but do not fully tighten screws yet.
4. Squeeze the handle completely and firmly strike the pull up lever against a non-metal surface to actuate the knife - Figure 2 (note: you may also press firmly on the pull up lever to actuate the knife - Figure 3).

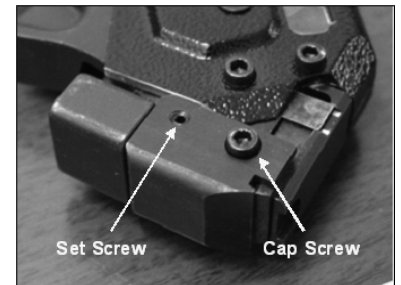

Figure 1



Figure 2

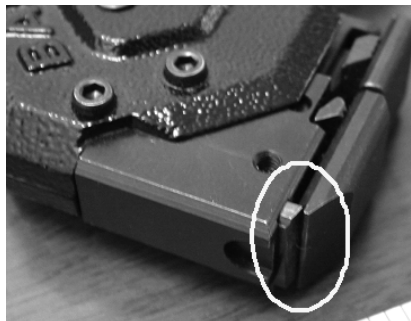

Figure 3

5. The knife is now in the downward position - Figure 4.

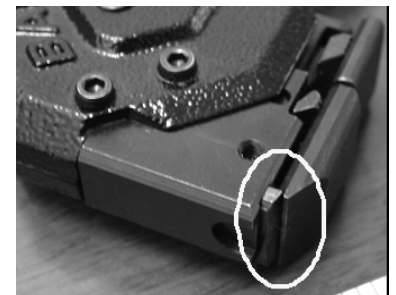

Figure 4

Installation Procedure Continued:

6. Open the tension handle slightly so that the knife retracts from its full stroke; it should be overlapping the blade edge - Figure 5.
7. Using the edge of a table or bench, force the pull up lever against the blade. This will force the blade against the knife and ensure a zero-gap - Figure 6.
8. Tighten the cap screw 1/2 turn past snug.
9. Tighten the set screw 1/2 turn past snug.

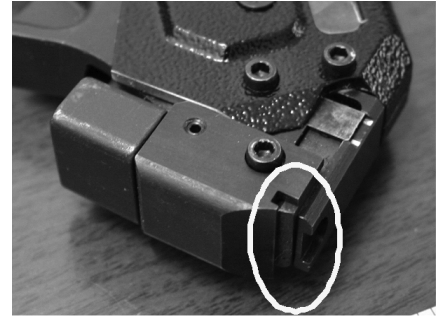

Figure 5

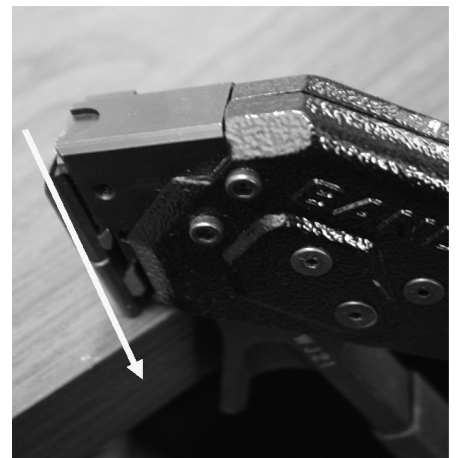

Figure 6